

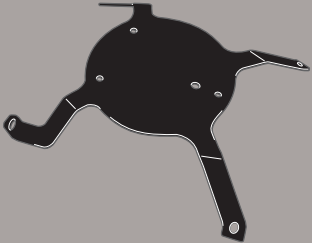





BF19-BF19K

Flangia Specifica per borse Tanklock - Specific Carrier for Tanklock bags
Brides spécifiques pour Tanklock bagagerie souple - Tankringen für tanklock Weichtaschen Aro específico para bolsas
Tanklock - Anel específico para sacos Tanklock

N°	Descrizione	Caratteristiche	Codice	Quantità	
1	Flangia - Support Brides - Tankringen - Aro - Anel	-	GL1700	1	
2	Supporto - Support Support - Halterung Soporte - Suporte	Sp. 2mm	GL2622P	1	
3	Vite - Screw Vis - Schraube Tornillo - Parafuso	TBEI M5x25	525TBEI	4	
4	Vite - Screw Vis - Schraube Tornillo - Parafuso	TBEI M4x12 INOX	412TBEIX	3	
5	Distanziale - Spacer Entretoise - Distanzstueck Distanciador - Espaçador	Ø10x5 foro 5.5mm	C10L5F5,5T	4	
6	Dado - Bolt - Ecrou Mutter - Tuerca - Porca	Auto Bloccante M4	4DADIAU	3	
7	Rondella - Washer Rondelle - Scheibe Arandela - Arruela	Ø5	5RON	4	
8	Flangia - Support Brides - Tankringen - Aro - Anel	-	ZT480F	-	

BF19-BF19K

Flangia Specifica per borse Tanklock - Specific Carrier for Tanklock bags
Brides spécifiques pour Tanklock bagagerie souple - Tankringen für tanklock Weichtaschen Aro específico para bolsas
Tanklock - Anel específico para sacos Tanklock

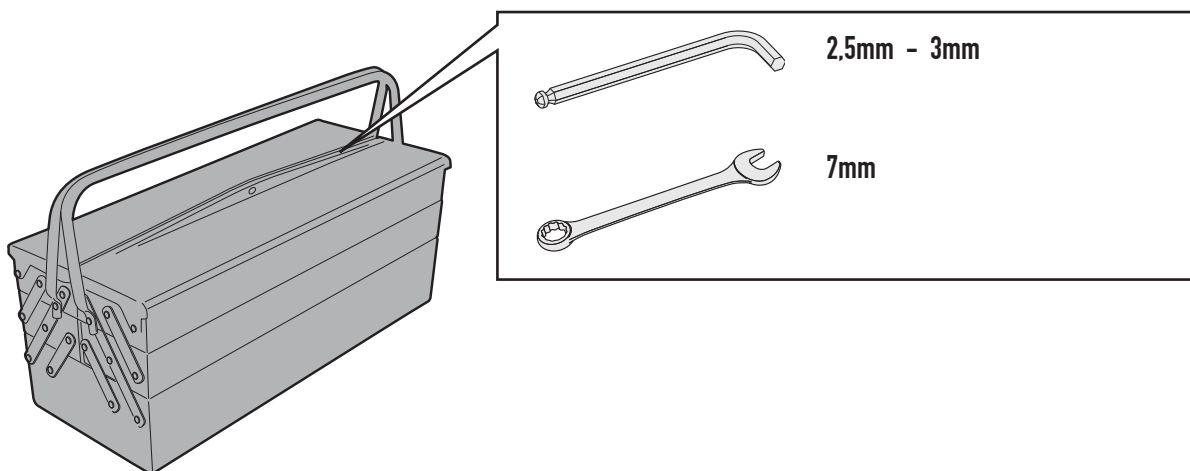

BF19-BF19K

Flangia Specifica per borse Tanklock - Specific Carrier for Tanklock bags
Brides spécifiques pour Tanklock bagagerie souple - Tankringen für tanklock Weichtaschen Aro específico para bolsas Tanklock - Anel específico para sacos Tanklock

