

A1159 - KA1159

ATTACCHI SPECIFICI PER - SPECIFIC FITTING KIT FOR - KIT DE MONTAGE SPECIFIQUE POUR
SPEZIFISCHER MONTAGEKIT FÜR - ANCLAJE ESPECÍFICO PARA - ANCORADOURO ESPECÍFICO

HONDA CB650F (2017)

N°	Descrizione	Caratteristiche	Codice	Quantità
1	Supporto - Support - Support Halterung - Soporte - Apoio	-	A1159DXV A1159SXV	2 (Dx,Sx)
2	Vite - Screw Vis - Schraube Tornillo - Parafuso	TCEI M6X55	655TCEI	2
3	Vite - Screw Vis - Schraube Tornillo - Parafuso	TBEIFN M6X14	614TBEIFN	4
4	Rondella In Nylon - Nylon Washer Rondelle Original En Nylon - Nylonscheibe Arandela De Nylon - Arruela De Nylon	-	Z1979	4
5	Rondella In Gomma - Rubber Washer Rondelle En Gomme - Gummscheibe Arandela De Goma - Arruela De Borracha	-	ORONG	4
6	Distanziale - Spacer Entretoise - Distanzstueck Distanciador - Espaçado	-	V064	2
7	Tappo - Cap Fiche - Stecker Enchufe - Boné	-	Z822	2
8	Schermo Specifico - Specific Screen Écran Spécifique Spezifischen Bildschirm Pantalla Especifica - Tela Especifica	-	-	1

A1159 - KA1159

ATTACCHI SPECIFICI PER - SPECIFIC FITTING KIT FOR - KIT DE MONTAGE SPECIFIQUE POUR
SPEZIFISCHER MONTAGEKIT FÜR - ANCLAJE ESPECÍFICO PARA - ANCORADOURO ESPECÍFICO

HONDA CB650F (2017)

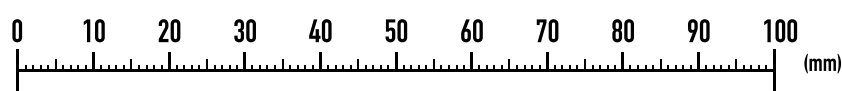
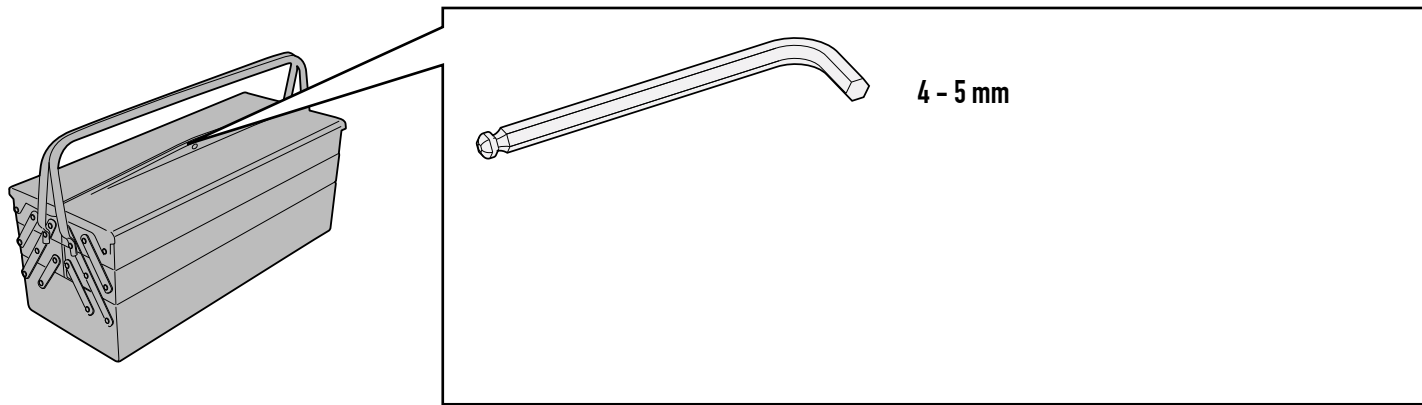
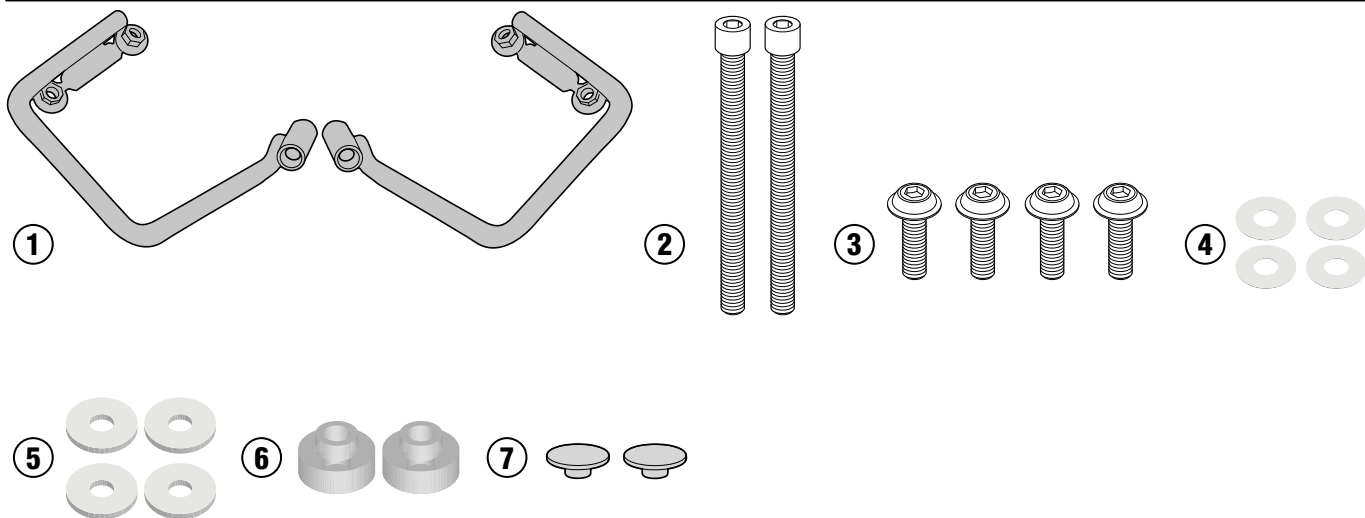

A1159 - KA1159

ATTACCHI SPECIFICI PER - SPECIFIC FITTING KIT FOR - KIT DE MONTAGE SPECIFIQUE POUR
SPEZIFISCHER MONTAGEKIT FÜR - ANCLAJE ESPECÍFICO PARA - ANCORADOURO ESPECÍFICO

HONDA CB650F (2017)

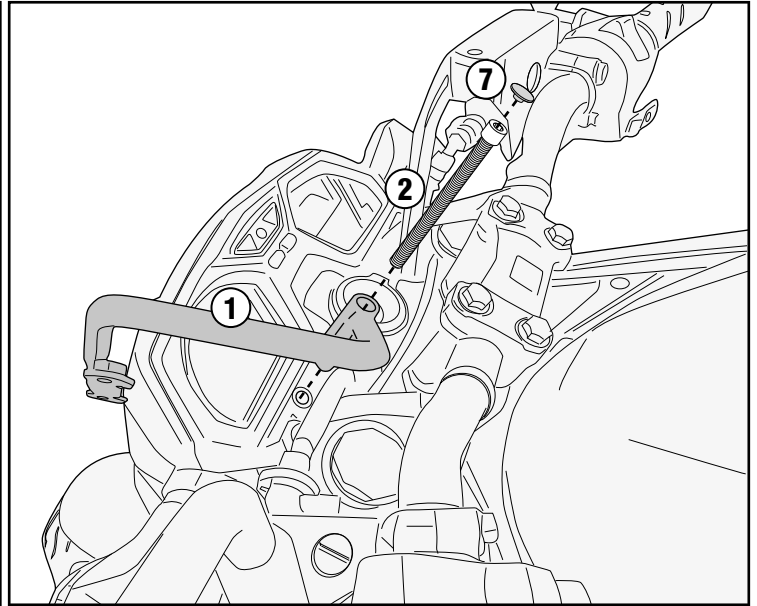
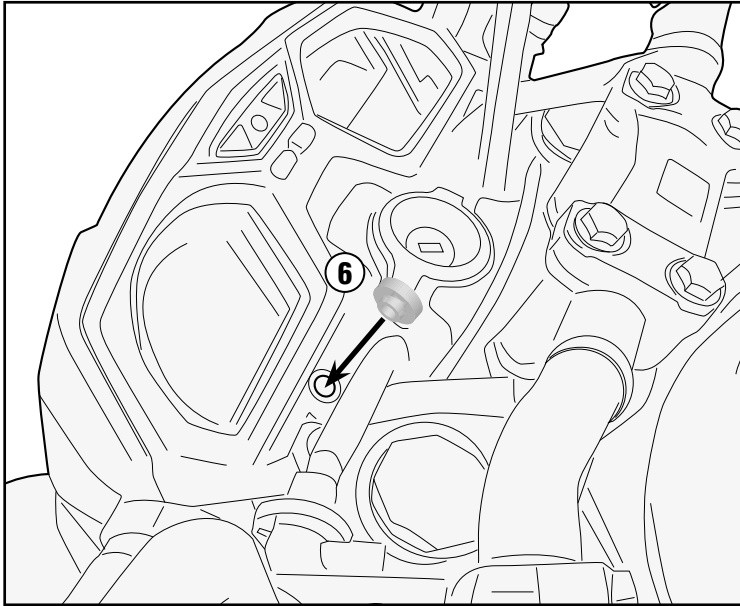

- ATTENZIONE AL POSIZIONAMENTO DEI CAVI
- BE AWARE OF CABLE POSITIONING
- ATTENTION A LA POSITION DES CABLES
- ATENCIÓN AL POSICIONAMIENTO DEL CABLE
- VORSICHT BEI DER POSITIONIERUNG DER KABEL
- ATENÇÃO AO POSICIONAMENTO DOS CABOS

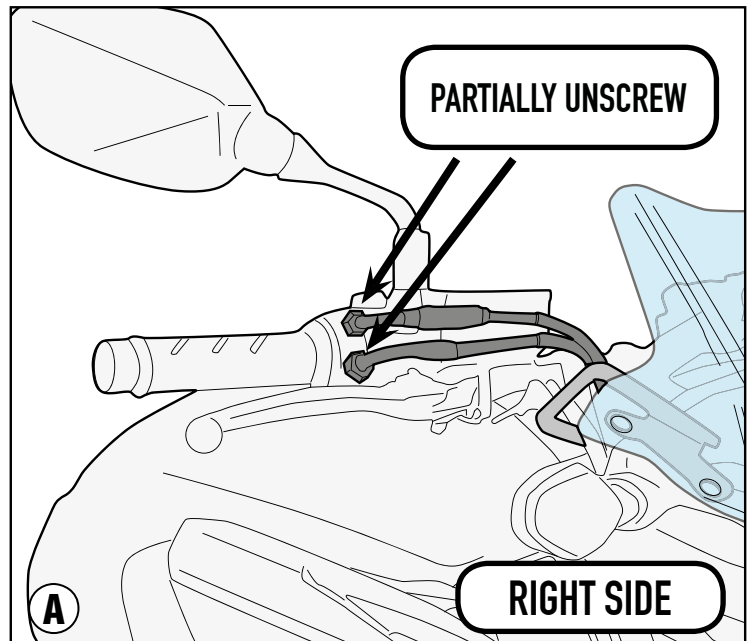
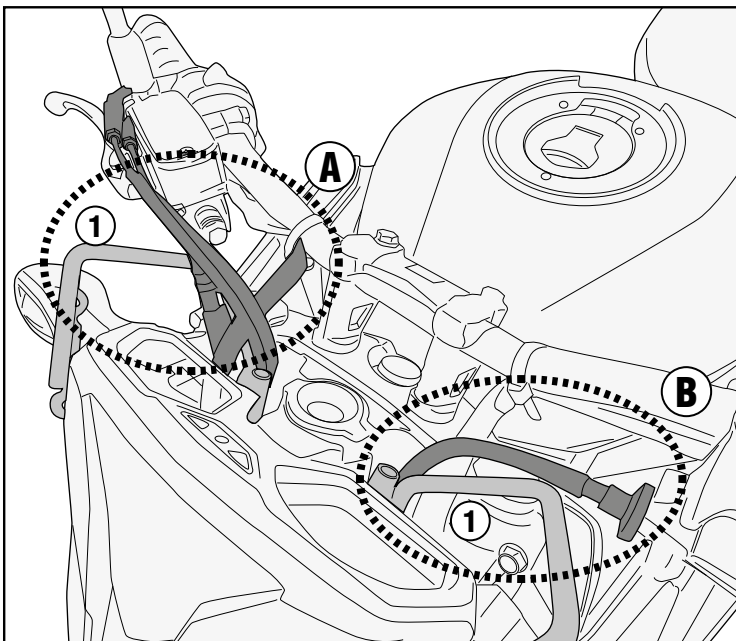

A1159 - KA1159

ATTACCHI SPECIFICI PER - SPECIFIC FITTING KIT FOR - KIT DE MONTAGE SPECIFIQUE POUR
SPEZIFISCHER MONTAGEKIT FÜR - ANCLAJE ESPECÍFICO PARA - ANCORADOURO ESPECÍFICO

HONDA CB650F (2017)

