

SRA5146 - KRA5146

PORTAPACCO SPECIFICO - SPECIFIC HOLDER - PORTE-PAQUET SPÉCIFIQUE - SPEZIFISCHER TRÄGER - PORTA-EQUIPAJE ESPECÍFICO

N°	Descrizione/Description	Caratteristiche/Features	Codice/Code	Quantità/Quantity
1	Piastra - Plate - Platine - Platte Parrilla - Grelha	-	GL5998AN	1
2	Supporto inferiore - Lower support - Support inférieur Soporte inferior - Untere Halterung - Suporte inferior	-	GL5999DX GL5999SX	2(Right:Left)
3	Supporto - Support - Support Halterung - Soporte - Suporte	-	GL6000V	1
4	Supporto anteriore - Front support -Support avant Vordere Unterstützung - Soporte frontal - Suporte frontal	-	GL6001DX GL6001SX	2(Right:Left)
5	Vite - Screw - Vis - Schraube Tornillo - Parafuso	M8x55 TBEI	855TBEI	2
6	Vite - Screw - Vis - Schraube Tornillo - Parafuso	M8x65 TBEI	865TBEI	2
7	Vite - Screw - Vis - Schraube Tornillo - Parafuso	M8x30 TBEI	830TBEI	2
8	Vite - Screw - Vis - Schraube Tornillo - Parafuso	M6x20 TSP	620TSP	5
9	Rondella spaccata - Split washer Scheibe - Rondelle fendue Arandela seccionada - Arruela Dentada	Foro Ø8mm	Z1060	4
10	Rondella - Washer Rondelle - Scheibe Arandela - Arruela	Foro Ø8mm	8RON	6
11	Distanziale - Spacer - Entretoise - Distanzstueck Distanciador - Espaçador	Ø20x10 Foro 8.5mm	C20L10F8.5T	2
12	Distanziale - Spacer - Entretoise - Distanzstueck Distanciador - Espaçador	Ø20x22 Foro 8.5mm	C20L22F8.5T	2
13	Dado - Bolt - Erou Mutter - Tuerca - Porca	Dado Autobloccante Flangiato M8 (H.9mm)	8DADIFN	2
14	Dado - Bolt - Erou Mutter - Tuerca - Porca	Dado Autobloccante Flangiato Alto M6 (H.9mm)	6DADIABFN	5
15	Componenti Originali - Original Parts Parties Originales - Original Bauteile Componentes Originales - Componentes Originais	-	-	-

SRA5146 - KRA5146

PORTAPACCO SPECIFICO - SPECIFIC HOLDER - PORTE-PAQUET SPÉCIFIQUE - SPEZIFISCHER TRÄGER - PORTA-EQUIPAJE ESPECÍFICO

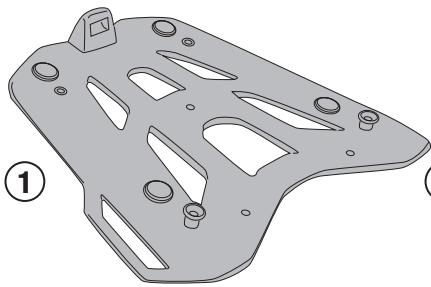

GL5998AN

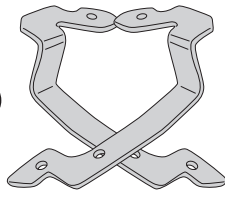

GL5999SX / GL5999DX

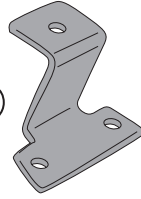

GL6000V

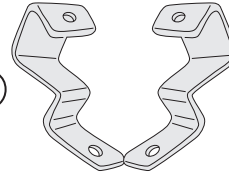

GL6001DX / GL6001SX

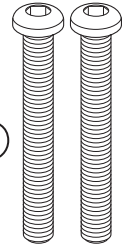

M8x55mm

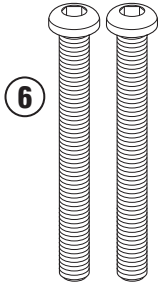

M8x65mm

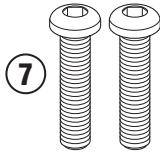

M8x30mm

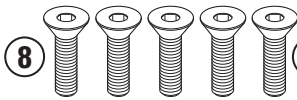

M6x20mm



Hole Ø8mm



Hole Ø8mm



Hole Ø8.5mm/
External Ø20mm/
H.10mm



Hole Ø8.5mm/
External Ø20mm/
H.22mm

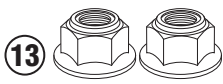

M8

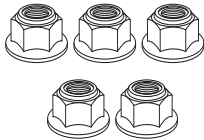

M6

IT_ Nel caso in cui sulle viti originali sia presente del frenafili, ripristinarlo durante il montaggio dell'accessorio.

EN_ If there is threadlocker on the original screws, use threadlocker when mounting the accessory.

DE_ Falls sich auf den Originalschrauben Schraubensicherungsstoff befand, sollte dieser auch bei der Montage des Zubehörs wieder aufgetragen werden

FR_ Si du frein filet est présent sur les vis d'origine, l'appliquer également lors du montage de l'accessoire

ES_ En caso de que el fijador de roscas se encuentre presente en los tornillos originales, colocarlo nuevamente en el montaje del accesorio

PT_ Se houver trava rosca nos parafusos originais, inserir novamente durante a montagem do acessório

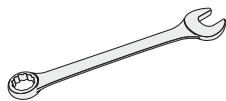
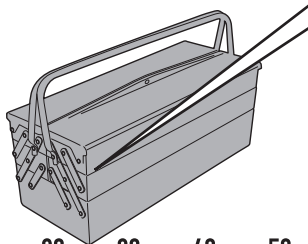

10mm / 13mm

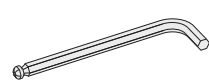

4mm / 5mm



T30

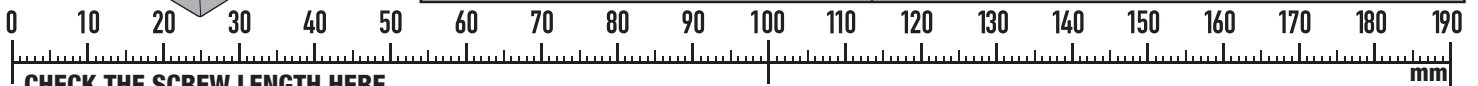

CHECK THE SCREW LENGTH HERE

ISTRUZIONI DI MONTAGGIO - MOUNTING INSTRUCTIONS
INSTRUCTIONS DE MONTAGE - BAUANLEITUNG
INSTRUCCIONES DE MONTAJE - INSTRUÇÕES DE MONTAGEM

SRA5146 - KRA5146

PORTAPACCO SPECIFICO - SPECIFIC HOLDER - PORTE-PAQUET SPÉCIFIQUE - SPEZIFISCHER TRÄGER - PORTA-EQUIPAJE ESPECÍFICO

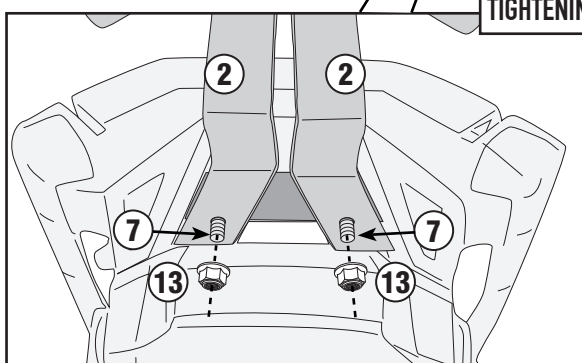
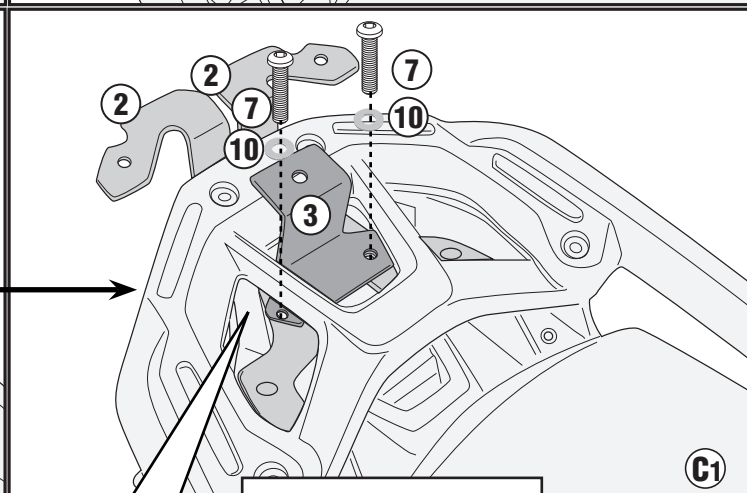
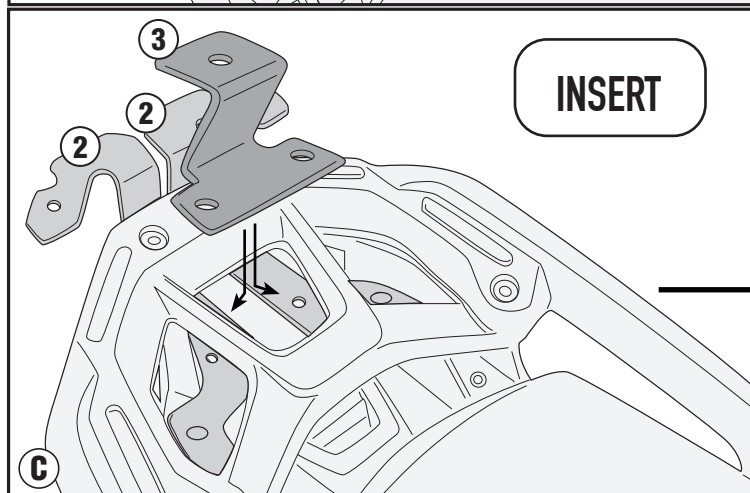
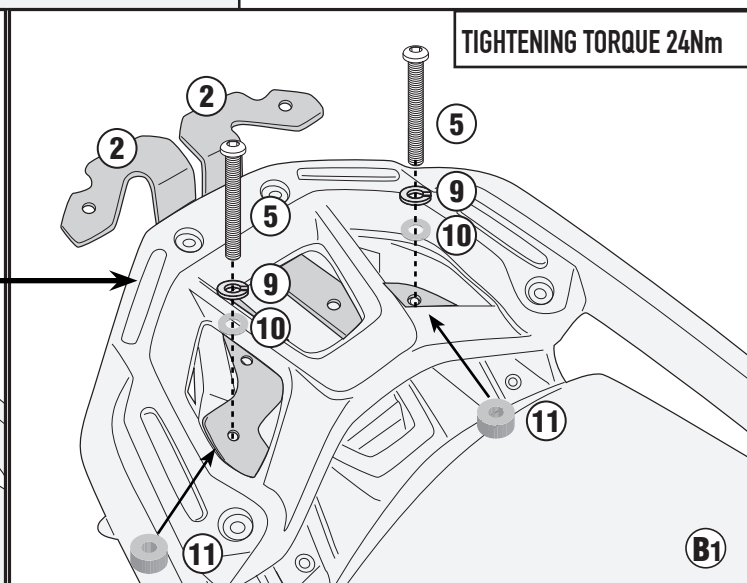
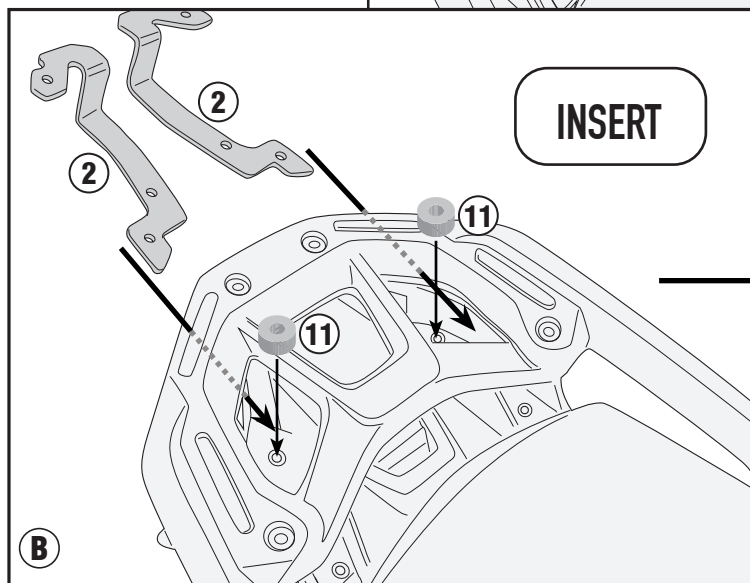
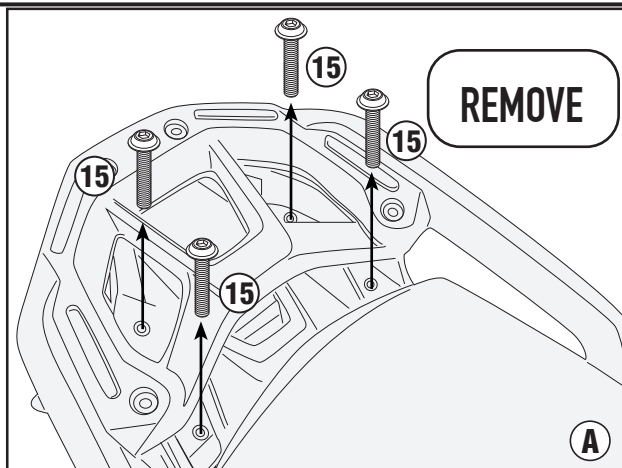

ISTRUZIONI DI MONTAGGIO - MOUNTING INSTRUCTIONS
INSTRUCTIONS DE MONTAGE - BAUANLEITUNG
INSTRUCCIONES DE MONTAJE - INSTRUÇÕES DE MONTAGEM

SRA5146 - KRA5146

PORTAPACCO SPECIFICO - SPECIFIC HOLDER - PORTE-PAQUET SPÉCIFIQUE - SPEZIFISCHER TRÄGER - PORTA-EQUIPAJE ESPECÍFICO

