

MONORACK SPECIFICO - SPECIFIC MONORACK
MONORACK SPECIFIQUE - SPEZIFISCHES MONORACK - MONORACK ESPECÍFICO

HONDA HORNET 600

2011

ISTRUZIONI DI MONTAGGIO - MOUNTING INSTRUCTIONS
INSTRUCTIONS DE MONTAGE - BAUANLEITUNG - INSTRUCCIONES DE MONTAJE

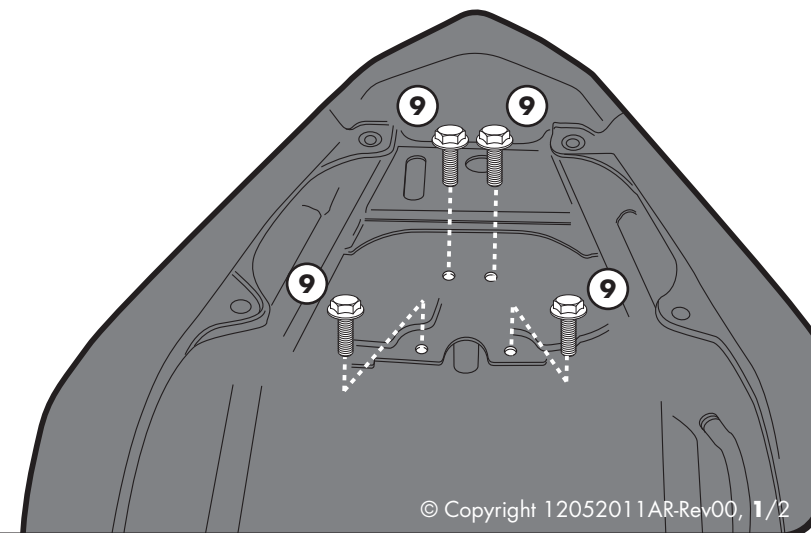
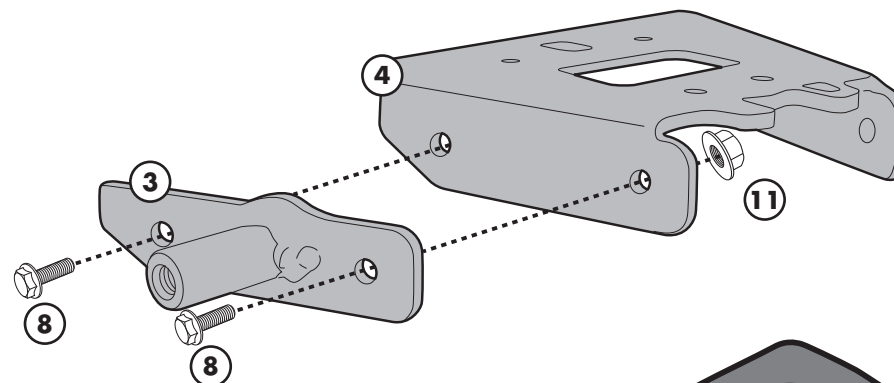
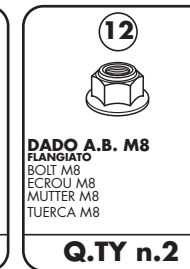
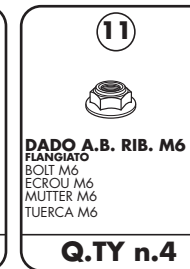
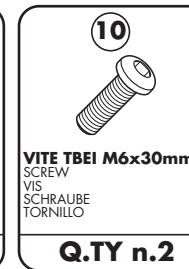
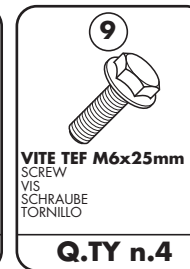
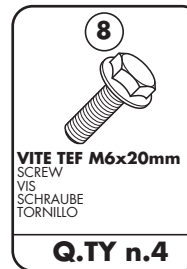
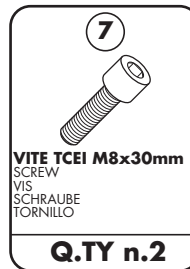
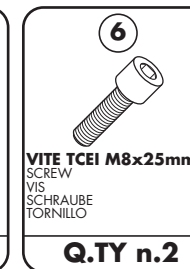
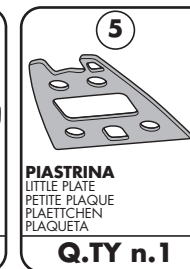
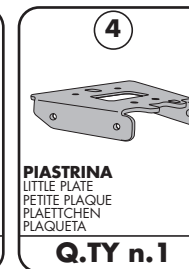
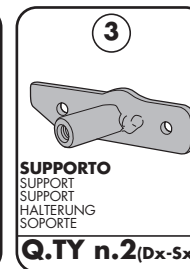
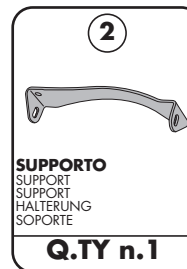
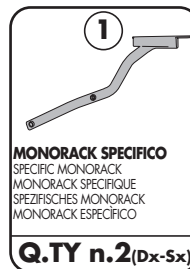
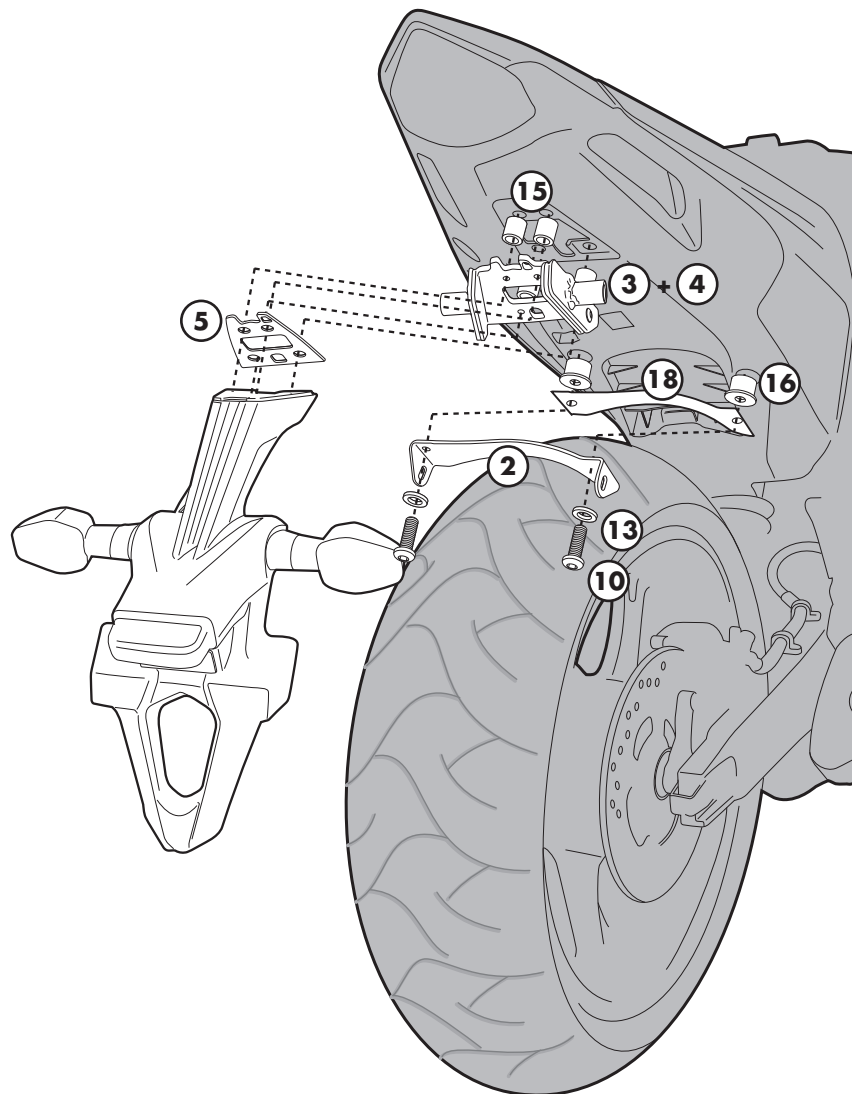

MONORACK SPECIFICO - SPECIFIC MONORACK
 MONORACK SPECIFIQUE - SPEZIFISCHES MONORACK - MONORACK ESPECÍFICO

HONDA HORNET 600

2011

ISTRUZIONI DI MONTAGGIO - MOUNTING INSTRUCTIONS
 INSTRUCTIONS DE MONTAGE - BAUANLEITUNG - INSTRUCCIONES DE MONTAJE

13



RONDELLA Ø6mm
 WASHER
 RONDELLE
 SCHEIBE
 ARANDELA

Q.TY n.2

14



DISTANZIALE Ø16x4mm
 Foro Ø8mm, V004
 SPACER
 ENTRETOISE
 DISTANZSTUECK
 DISTANCIADOR

Q.TY n.2

15



DISTANZIALE Ø12x5.5mm
 Foro Ø6,5mm, V704
 SPACER
 ENTRETOISE
 DISTANZSTUECK
 DISTANCIADOR

Q.TY n.4

16



DISTANZIALE V814
 SPACER
 ENTRETOISE
 DISTANZSTUECK
 DISTANCIADOR

Q.TY n.2

17



COPRIVITE Ø8mm
 Z801
 SCREW CAP
 CACHE VIS
 STOPSSCHRAUBE
 TAPA TORNILLO

Q.TY n.4

18

Z2121
 PROTEZIONE ADESIVA
 ADHESIVE PROTECTION
 PROTECTION ADHESIVE
 SCHUTZKLEBER
 PROTECCIÓN ADHESIVA

Q.TY n.1

